



Description

SETsafe | SETfuse 17AM is a miniature and high performance cost ratio for Thermal Motor Protector. The bimetal disc senses both heat and current from the equipment which 17AM is installed on. When the temperature of the disc reaches predetermined temperature point, the disc snap open the contacts, thus breaking the current path. When the equipment returns to a normal operating range, the 17AM protector resets (close circuit) automatically is in series with the load.

Features

- Current and Temperature Sensitivity
- Flexible Design and Wide Application
- RoHS & REACH Compliance



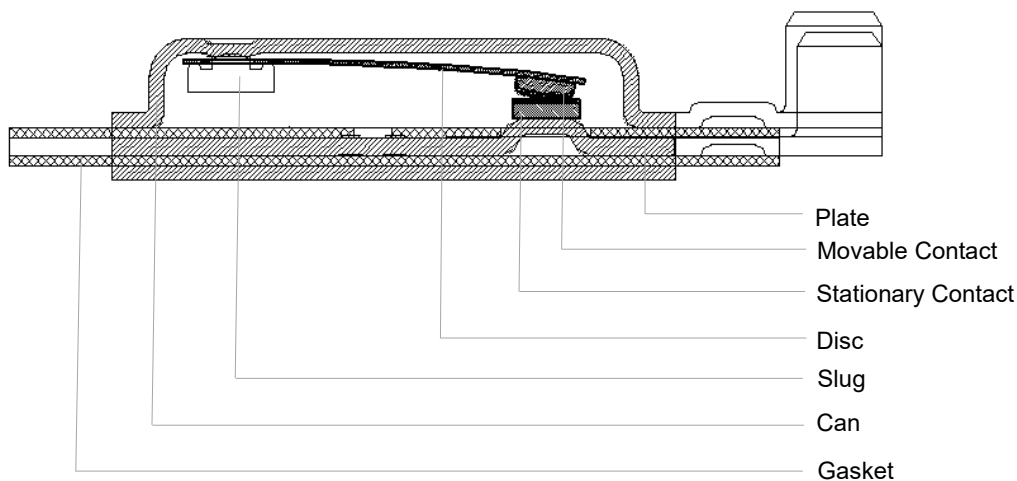

Applications

- Shaded Pole Motors
- Permanent Split Capacitor Motors
- Fluorescent Lighting Ballasts
- HID Ballasts
- Transformers
- Recessed Lighting Fixtures
- Automotive Accessory Motors
- Vacuum Cleaners
- Automotive Accessory Motors
- Solenoids
- PC Boards

Structure Diagrams



Agency Approvals

Agency	Standards	File No.
	UL60730-1 UL60730-2-22	E516554
	UL60730-1 UL60730-2-9	E516553
	UL60730-1 UL60730-2-3	E524531
	CSA E60730-1 CSA E60730-2-22	E516554
	CSA E60730-1 CSA E60730-2-9	E516553
	CSA E60730-1 CSA E60730-2-3	E524531
	EN 60730-1 EN 60730-2-22	R50532384
	EN 60730-1 EN 60730-2-9	R50532346
	EN 60730-1 EN 60730-2-3	R50547608
	GB/T14536.1-2008 GB/T14536.3-2008	CQC22002332056
	GB/T14536.1-2008 GB/T14536.10-2008	CQC22002332055
	GB/T14536.1-2008 GB 14536.4-2008	CQC22002332656

TMS

TMS

Part Numbering System

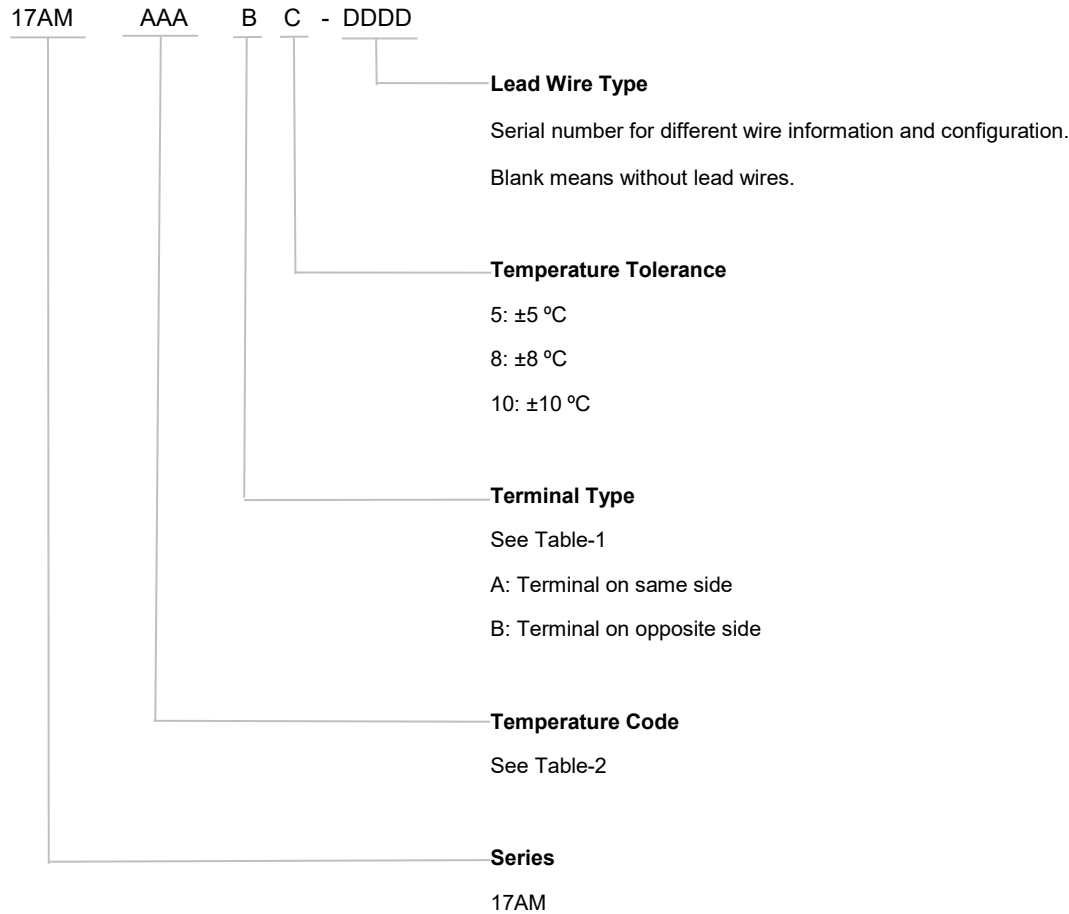

Glossary

Item	Description
Operating Temperature	Operating Temperature The actual temperature at which the thermal protector contacts are closed (normal open) or disconnected (normal close).
Recovery Temperature	Recovery Temperature After the thermal protector contact is closed or disconnected, the contact produces the actual temperature value corresponding to the open (normal open) or closed (normal close) contact.
Rated Current (I.)	Rated Current (I.) The current used to classify a thermal protector, which is the maximum current that Thermal Protector allows to carry and is able to cut off the circuit safely.
Rated Voltage (U.)	Rated Voltage (U.) The voltage used to classify a thermal protector, which is the maximum voltage that Thermal Protector allows to carry and is able to cut off the circuit safely.
Cycle Life	Cycle Life The number of periodic changes in the temperature of a bimetal element from its original state to its open (or closed) state.
Delta Temperature	Delta Temperature Is the difference between the zero current calibrated opening temperature and ambient temperature at the protector location.

Specifications

	Cycle Life	Rated Voltage (U_r)	Rated Current (I_r)
Contact Capacity	Cycles	(V)	(A)
	≥ 10,000	AC 277	8
	≥ 10,000	AC 120	15
	≥ 10,000	DC 24	15
Contact Resistance	≤ 50 mΩ		
Operating Temperature	50 ~ 180 °C - in increments of 5K		
Long-Term Service Temperature	-20 ~ 180 °C		
Electric Strength	1700 V r.m.s. 60 Hz, 1 minute, Lead to case		
Lead Wire Type	UL3135 18 AWG 600 V (other wire size is also available)		

TABLE-1 Terminal Type

Type	Dimensions (mm)	Type	Dimensions (mm)																						
A		B																							
	<table border="1"> <thead> <tr> <th>L</th> <th>H</th> <th>W</th> <th>W₁</th> </tr> <tr> <th>(±0.5)</th> <th>(±0.5)</th> <th>(±0.5)</th> <th>(±0.2)</th> </tr> </thead> <tbody> <tr> <td>23.4</td> <td>4.7</td> <td>10.6</td> <td>6.5</td> </tr> </tbody> </table>		L	H	W	W ₁	(±0.5)	(±0.5)	(±0.5)	(±0.2)	23.4	4.7	10.6	6.5	<table border="1"> <thead> <tr> <th>L</th> <th>H</th> <th>W</th> <th>W₁</th> </tr> <tr> <th>(±0.5)</th> <th>(±0.5)</th> <th>(±0.5)</th> <th>(±0.2)</th> </tr> </thead> <tbody> <tr> <td>26.3</td> <td>4.7</td> <td>10.6</td> <td>0.7</td> </tr> </tbody> </table>	L	H	W	W ₁	(±0.5)	(±0.5)	(±0.5)	(±0.2)	26.3	4.7
L	H	W	W ₁																						
(±0.5)	(±0.5)	(±0.5)	(±0.2)																						
23.4	4.7	10.6	6.5																						
L	H	W	W ₁																						
(±0.5)	(±0.5)	(±0.5)	(±0.2)																						
26.3	4.7	10.6	0.7																						

TABLE-2 Temperature Code (Bimetal Disc 70 ohms / cmf)

Temperature Code	Operating Temperature	Temperature Code	Operating Temperature
	±5 (°C)		±5 (°C)
017	50	031	120
018	55	032	125
019	60	033	130
020	65	034	135
021	70	035	140
022	75	036	145
023	80	037	150
024	85	038	155
025	90	039	160
026	95	040	165
027	100	041	170
028	105	042	175
029	110	043 ¹	180
030	115		

¹: There is no certification for this type of temperature

TMS

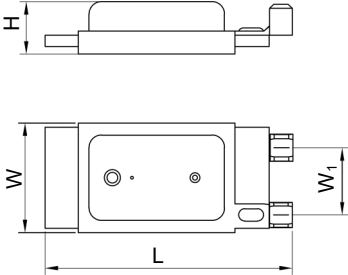
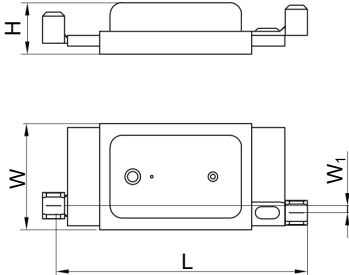
TMS

Ultimate Trip Current & Ambient Temperature

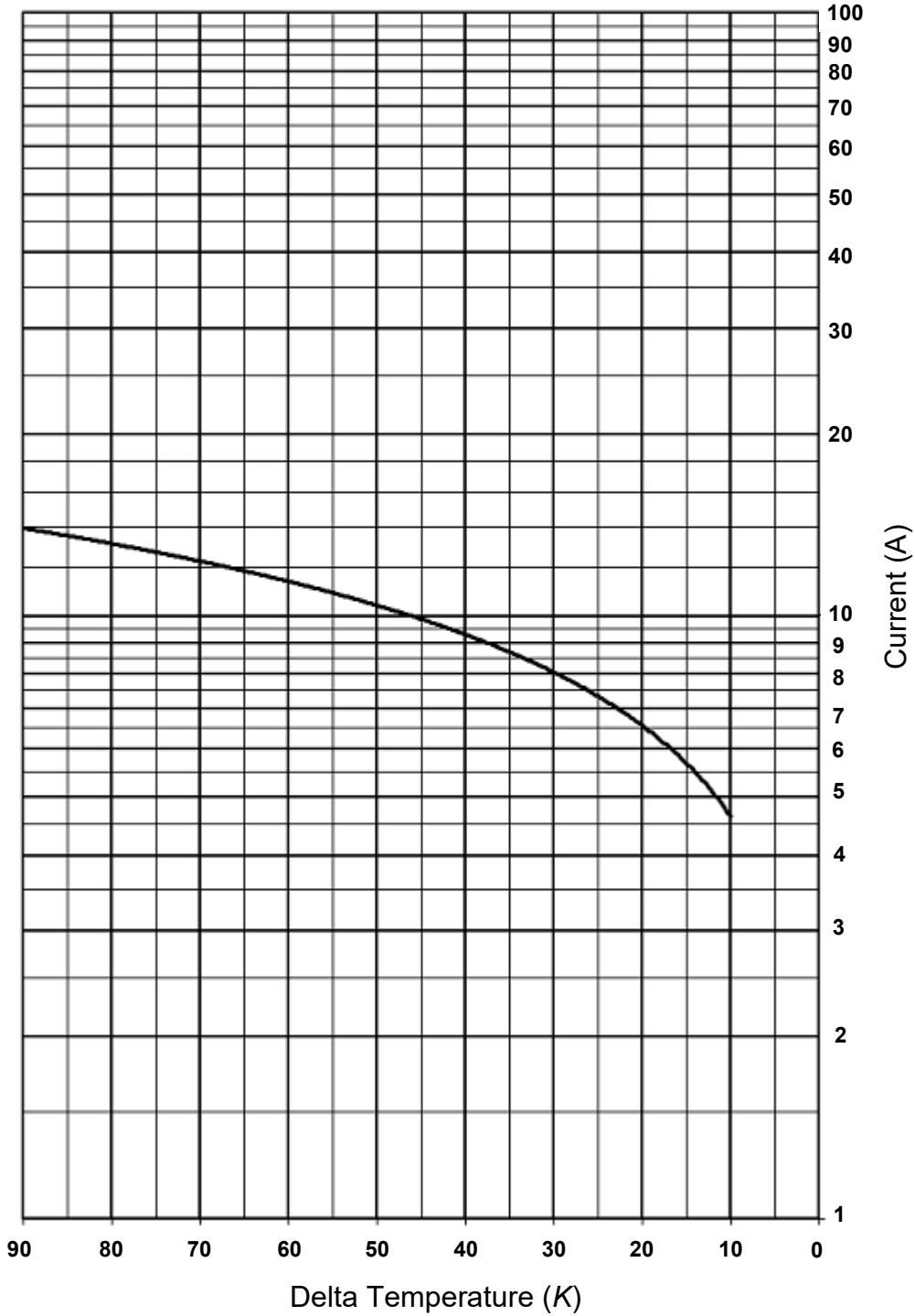

TMS

TMS

Packaging Information

Bulk (take Table-1 type A, wire 70 mm as an example)

Item	PE Bag	Carton
Dimensions (mm)	220 × 190	370 × 315 × 195
Quantity (PCS)	300	3000
Remark: The dimensions and quantity of packaging is for reference only		

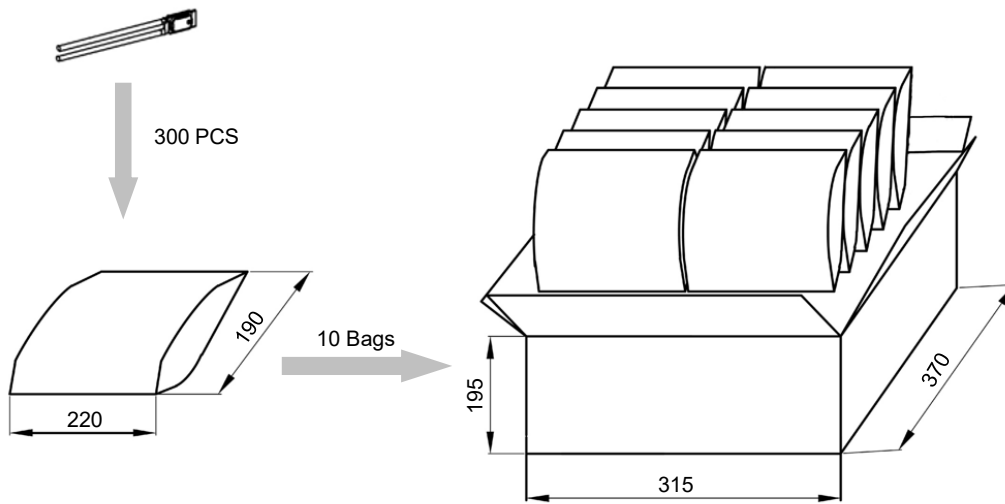

TMS

TMS



ATTENTION

Usage

1. These devices are not intended for use as service or repair components, strictly for use by Original Equipment Manufacturer. This product is not rated as explosion proof and should not be applied in any application where flammable vapors or dust is present. End of life failure of this device may result in either open or closed circuit condition, and as such, OEMs must apply end of life protection in series, per agency requirements.
2. Users are solely responsible for proper design, application and function of this product in the end product or system. Users must evaluate the suitability of these devices in their application with respect to Temperature Settings, Mechanical and Electrical Life Cycles, Electrical loads and Environmental conditions.
3. When atmosphere press is from 80 kPa to 106 kPa, the related altitude shall be from 2000 meter to -500 meter.

Replace

The product is a non-repairable product. For safety sake, it shall be replaced by an equivalent part and mounted in the same way.

Storage

Do not store the product at high temp, high humidity or corrosive gas environment, to avoid influencing the solder-ability or contact resistance of the lead wires. The product shall be used up within 1 year after your receiving goods.

Installation Position

1. The product should be as close to the protected parts as possible. For example, in the motor, the product should be embedded in the upper end of the motor stator coil. If the test conditions are met, the temperature field of the motor should be measured to determine the highest temperature point.
2. During the installation of the product, it is forbidden to strike by gravity, and the product shall not be extruded at the installation position, so as to avoid deformation of the product shell, which will seriously affect the protection performance of the product.

Warnings

Risk of Material Damage and Hot Enclosure

1. The product's side panels may be hot, allow the product to cool before touching.
2. Follow proper mounting instructions including force values. Failure to follow these instructions can result in serious injury, or equipment damage. Hazard of Electric Shock, Explosion or Arch Flash.
3. Verify all connections and replace all covers before turning on power. Failure to follow these instructions will result in death or serious injury.
4. Disconnect all power before installing or working with this equipment.